

**STANDARD PATTERNS
LUMBER ABBREVIATIONS**

BEV	Beveled
BEV SDG	Beveled siding
BS	Both sides
CB	Center Beaded
CB1S	Center bead one side
CB2S	Center bead two sides
CG	Center groove
CG2E	Center groove two edges
CLG	Ceiling
CM	Center matched
CS	Caulking seam
CSG	Casing
CV	Center Vee
CV1S	Center vee one side
CV2S	Center vee two sides
D2S	Dressed two sides
D4S	Dressed four sides
DB CLG	Double-beaded ceiling
DB PART	Double-beaded partition
DBL T&G	Double tongued & grooved
D&CM	Dressed & center matched
DKG	Decking
D/S,DS	Drop Siding
D S/L	Double shiplap
DVJM	Double vee-jointed matching
D&M	Dressed and matched
E	Edge
EB1S	Edge bead one side
EB2S	Edge bead two sides
E&CB2S	Edge & center bead two sides
EV1S	Edge vee one side
EV2S	Edge vee two sides
E&CV1S	Edge & center vee one side
E&CV2S	Edge & center vee two sides
EE	Eased Edges
EG	Edge (vertical) grain
EM	End matched
EV	Edge vee
FE	Feathered edge
FG	Flat (slash) grain
FLG	Flooring
F&G	Feathered & grooved
G1E	Grooved one edge
HB	Hollow back
MG	Mixed Grain
N	Nosed

N1E	Nosed one edge
N2E	Nosed two edges
OS	One side
PAT	Pattern
P1E	Planed one edge
P2E	Planed two edges
P1S	Planed one side
P2S	Planed two sides
P4S	Planed four sides
P1S1E	Planed one side one edge
P2S1E	Planed two sides one edge
P1S2E	Planed one side two edges
PAR	Planed all 'round
PART	Partition
PE	Planed edge
PPE	Planed plain edge
PSE	Planed square edge
PSJ	Planed and square jointed
PTG	Planed tongued and grooved
R&B	Rabbit & bead
S	Side, Surfaced
SB1S	Single bead one side
SDG	Siding
SG	Slash (flat) grain
S/L, or SL	Shiplap
SQ	Square
STPG	Stepping
S&E	Side & edge (surfaced on)
S1E	Surfaced one edge
S2E	Surfaced two edges
S1S	Surfaced one side
S4S	Surfaced four sides
S1S&CM	Surfaced one side & center matched
S2S&CM	Surfaced two sides & center matched
S4S&CS	Surfaced four sides & caulking seam
S1S1E	Surfaced one side one edge
S1S2E	Surfaced one side two edges
S2S1E	Surfaced two sides one edge
S4SEE	Surfaced four sides eased edges
T&G	Tongued and grooved
TG&B	Tongued, grooved, and beaded
TG&V	Tongued, grooved, and vee-jointed
T1E	Tongued one edge
UE	Unedged
VG	Vertical grain
VJM	Vee-joint matching

Paneling

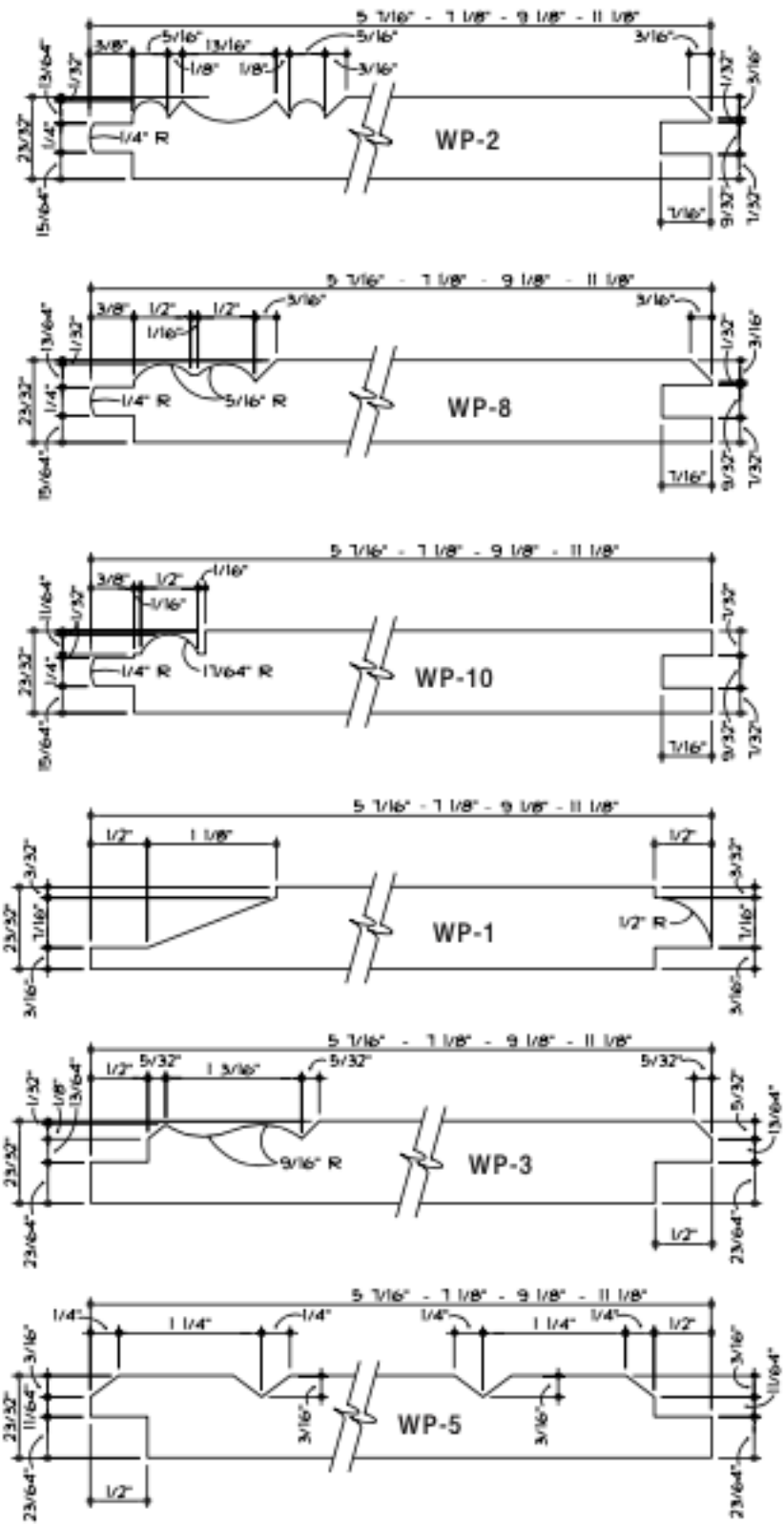

Paneling

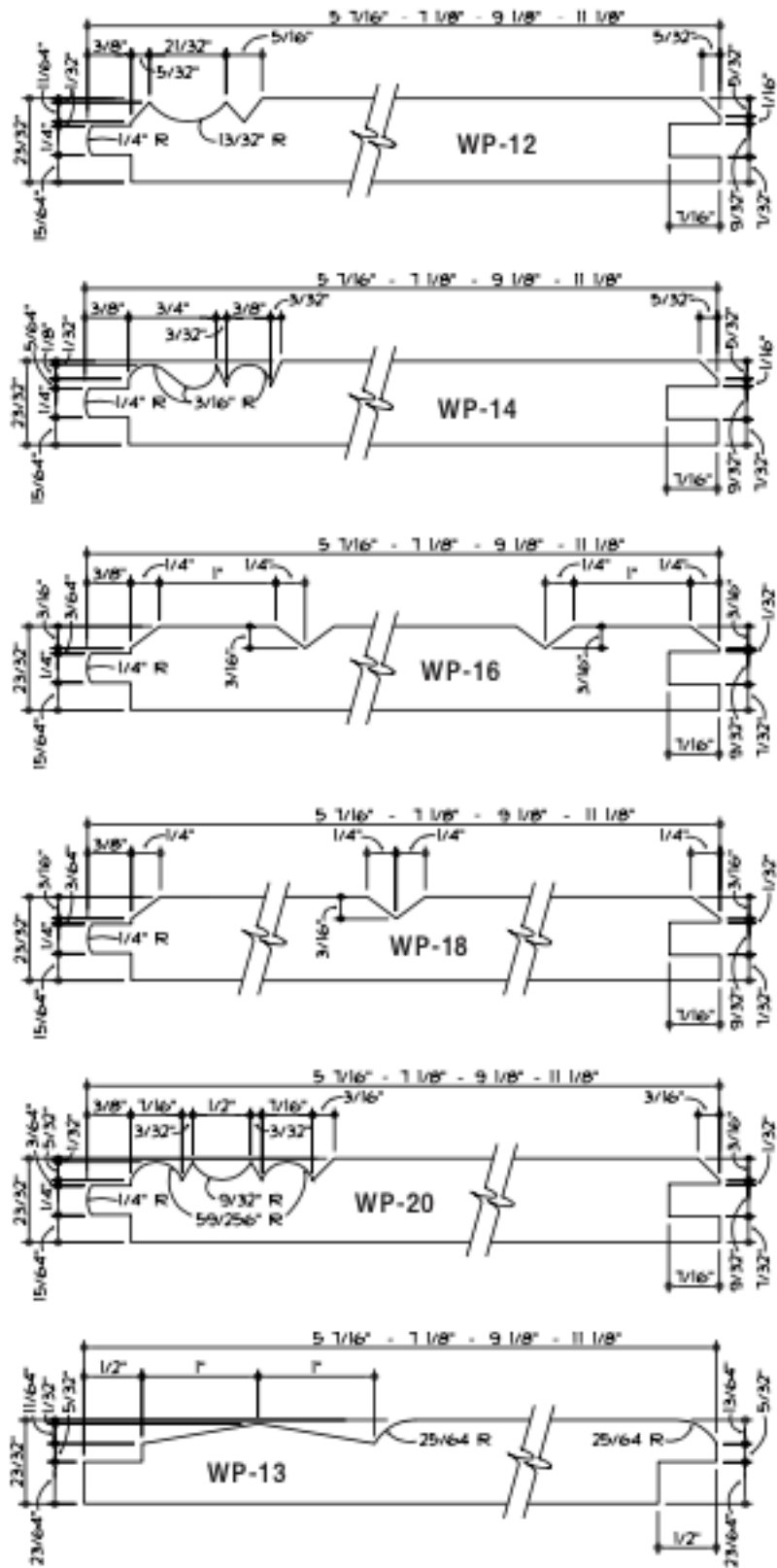

Paneling and Siding

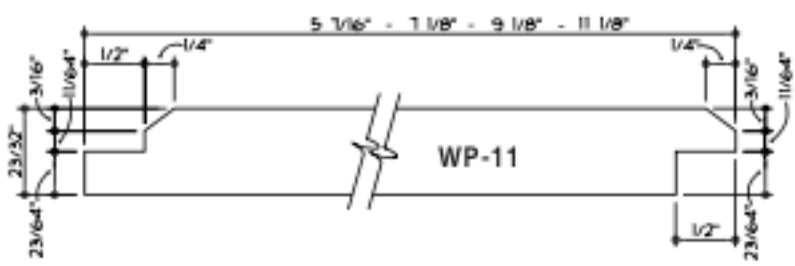
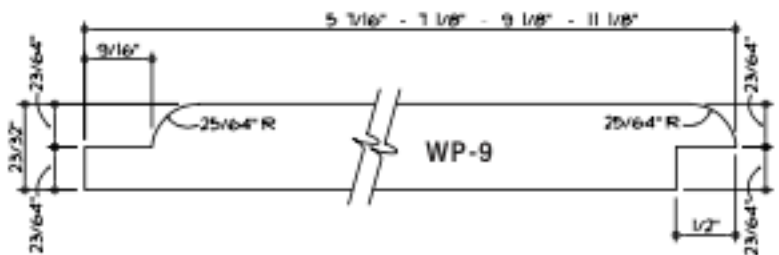
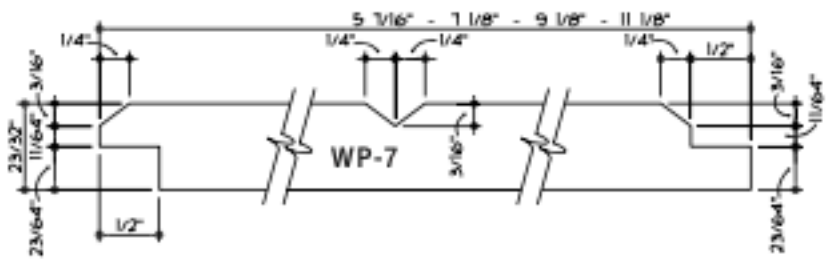
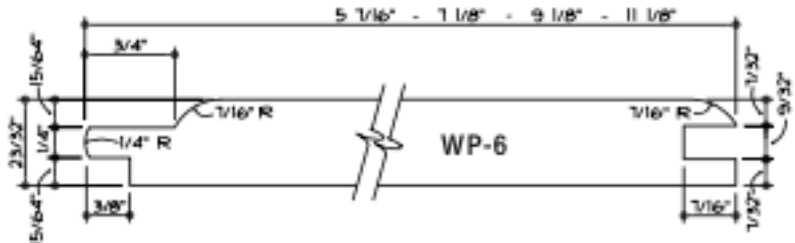
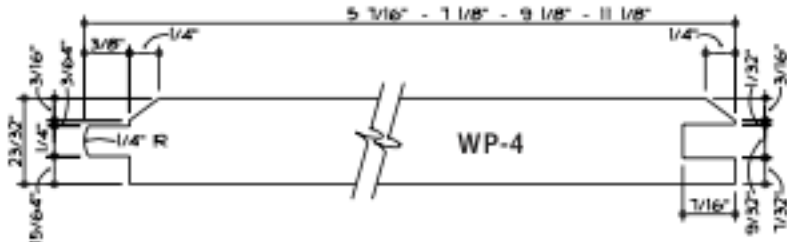
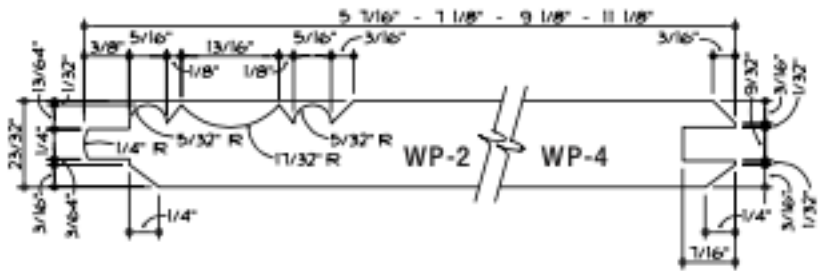

Siding

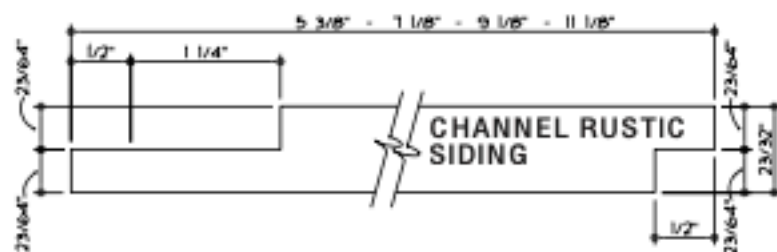
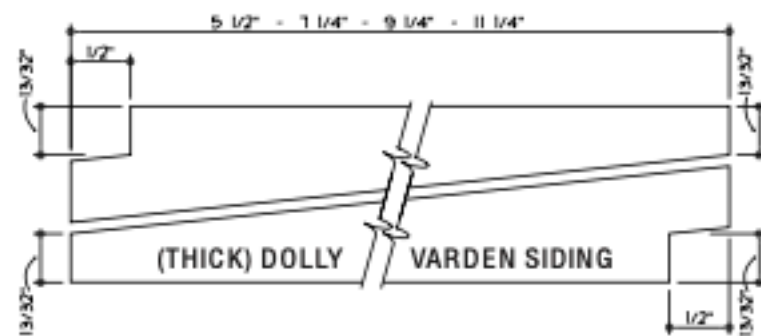
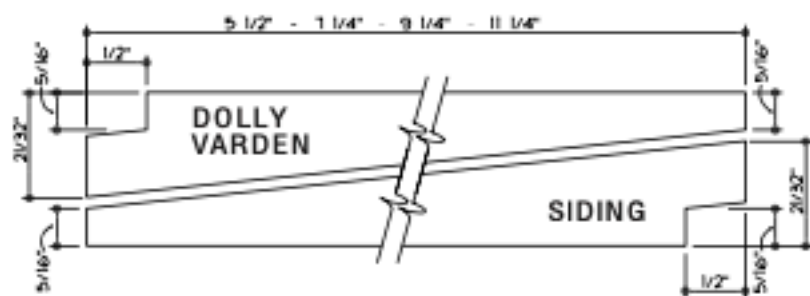
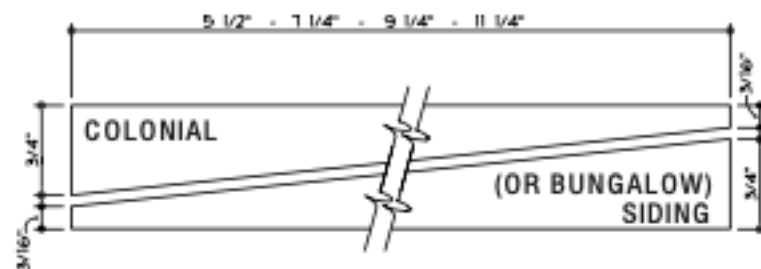
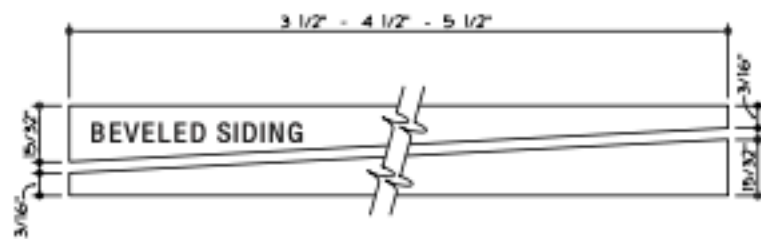

Siding

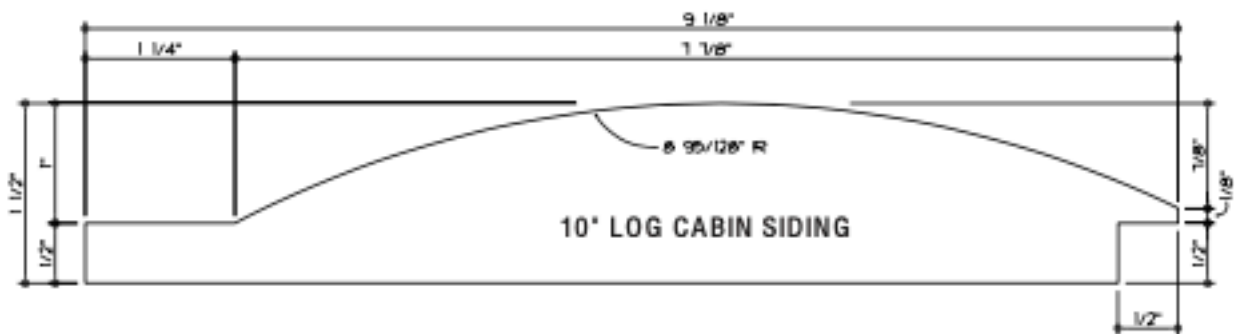
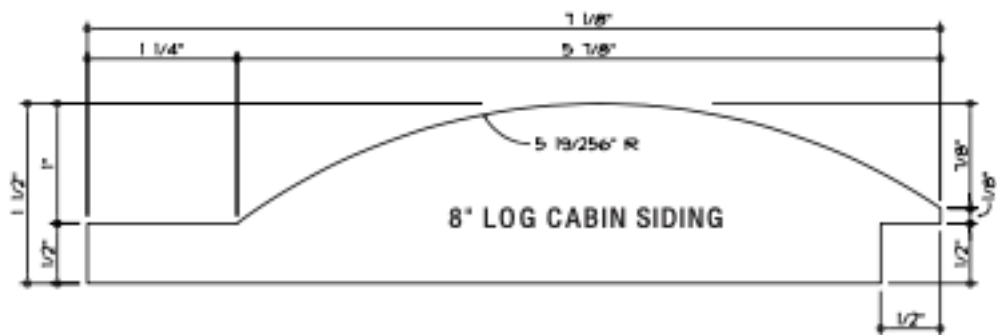
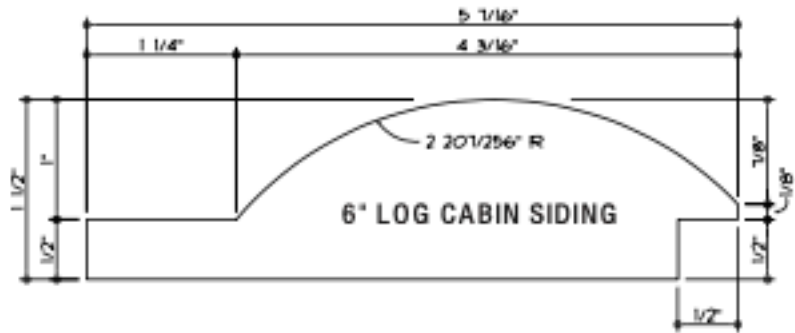

Siding

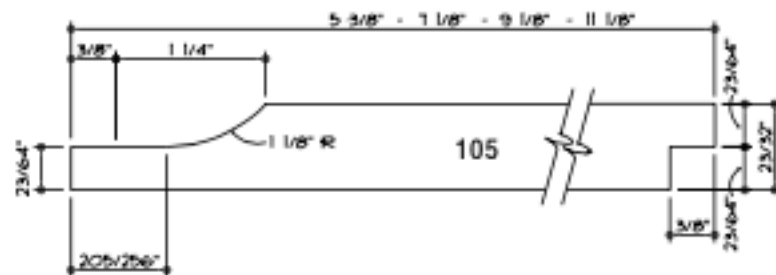
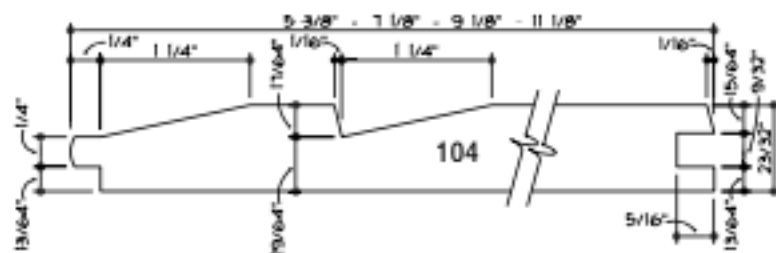
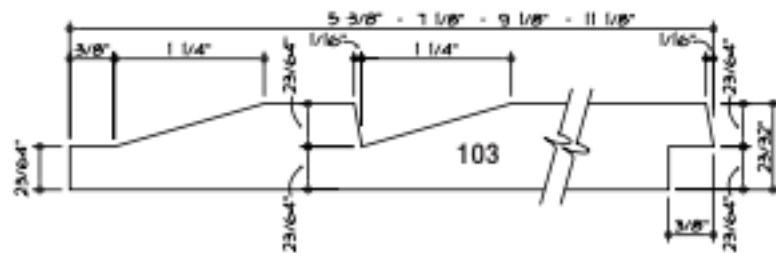
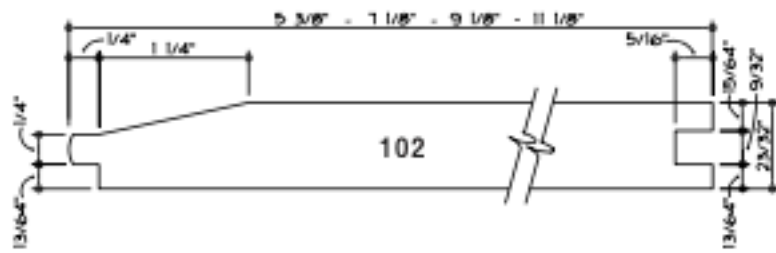
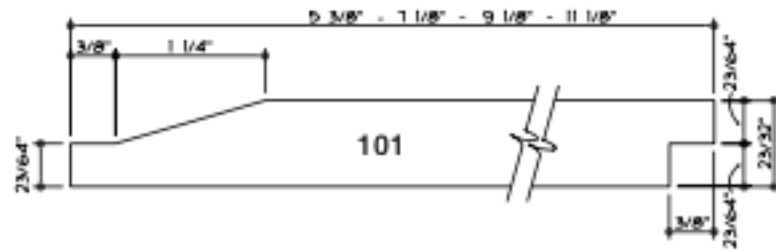

Siding

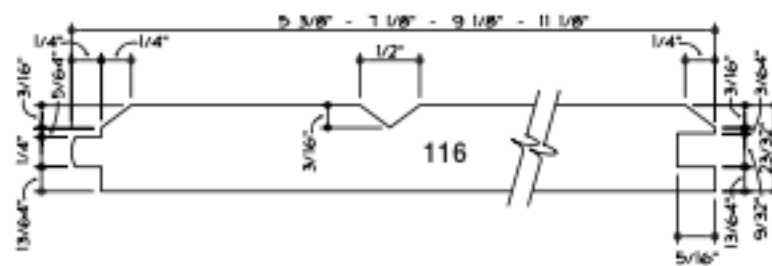
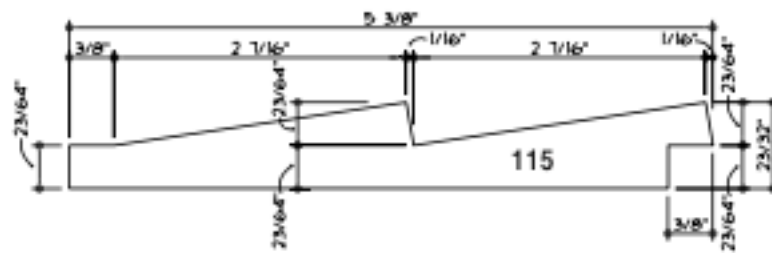
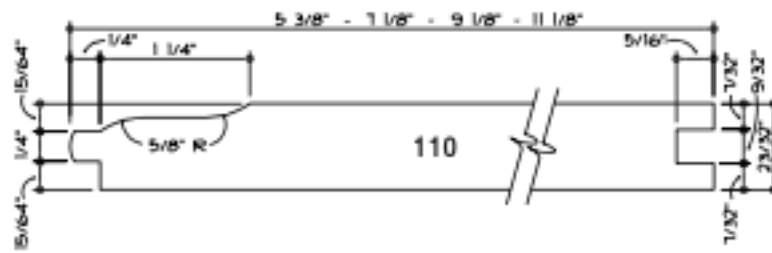
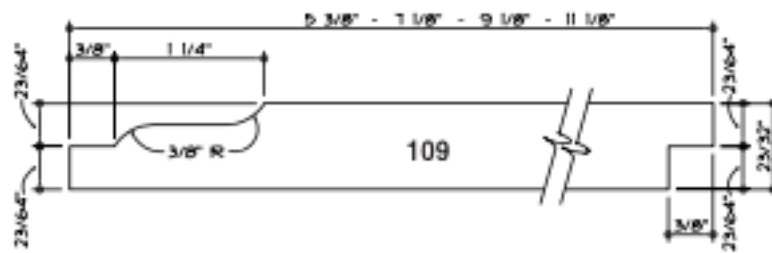
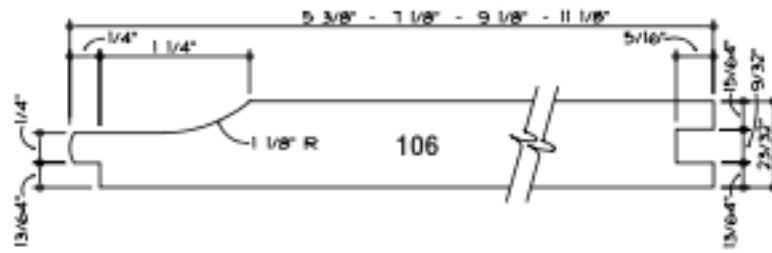

Siding

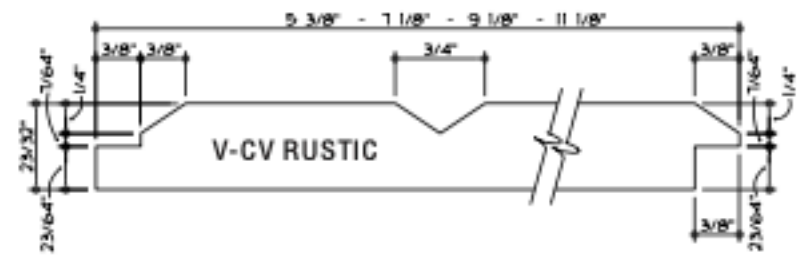
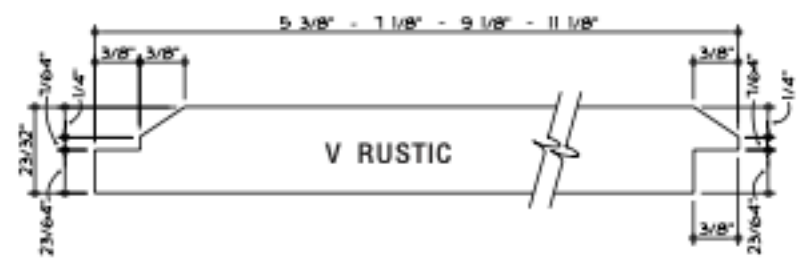
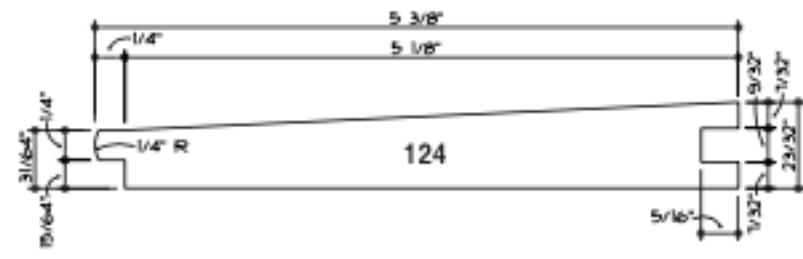
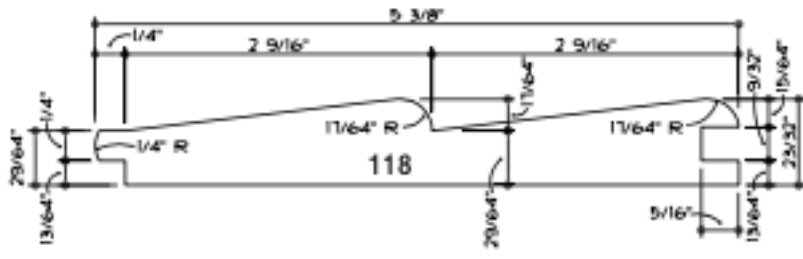
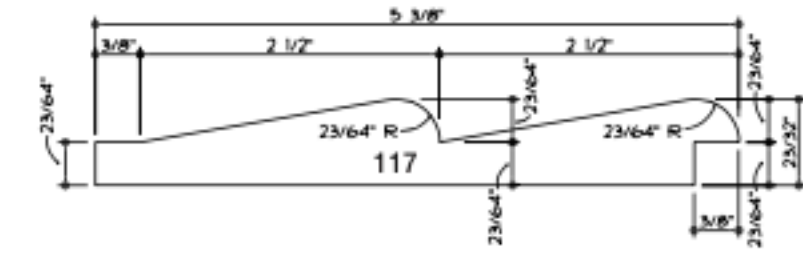

Ceiling

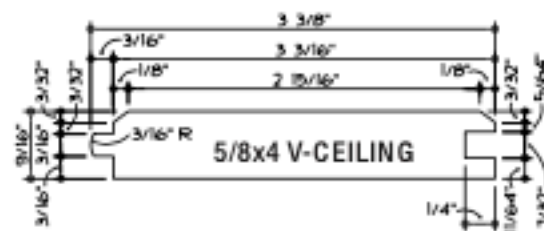
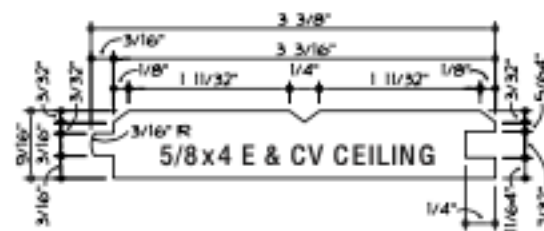
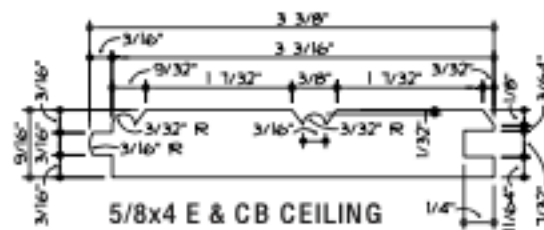
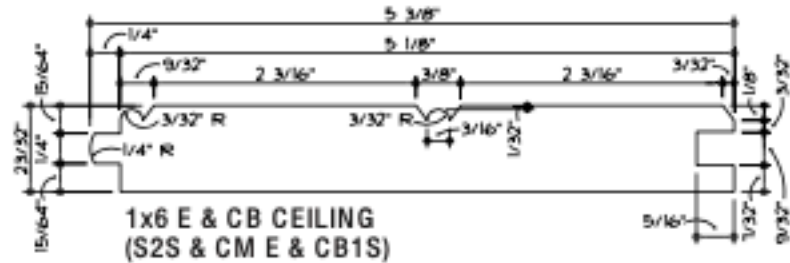
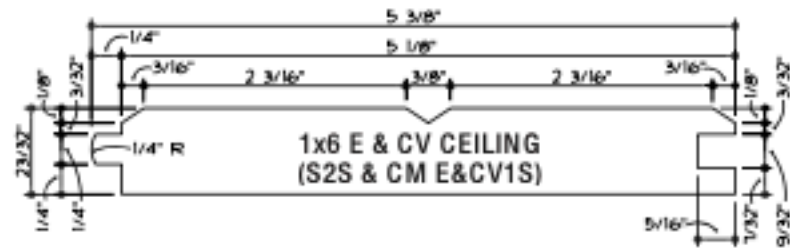
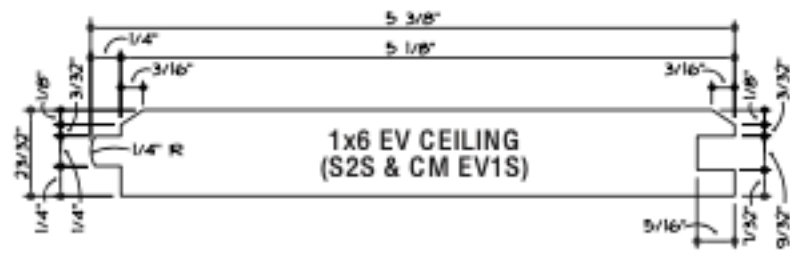

Ceiling and Partition

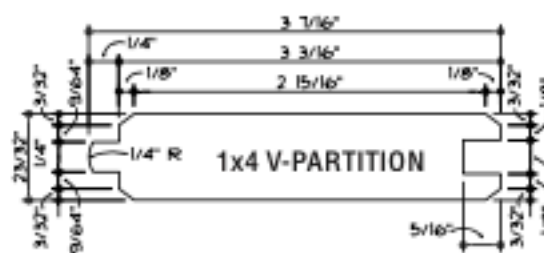
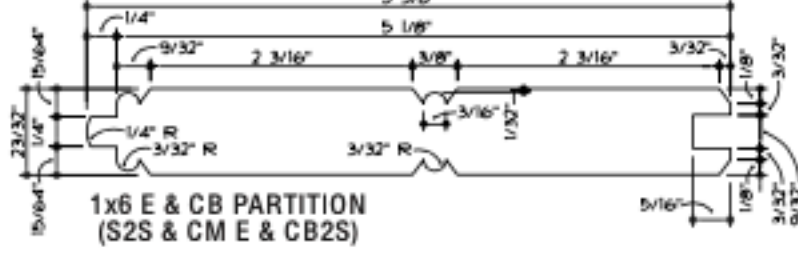
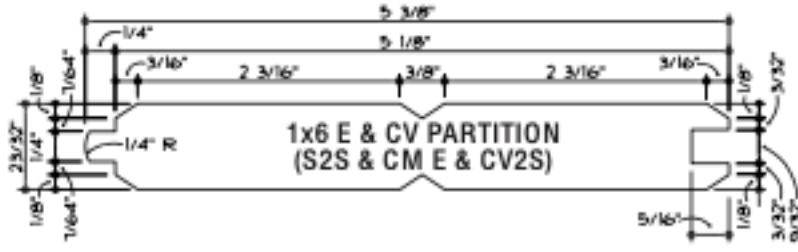
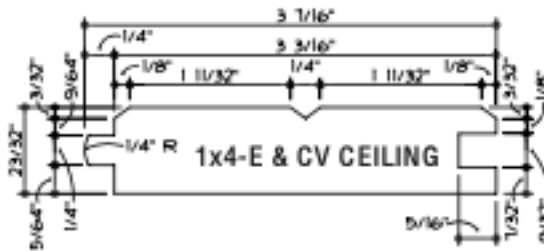
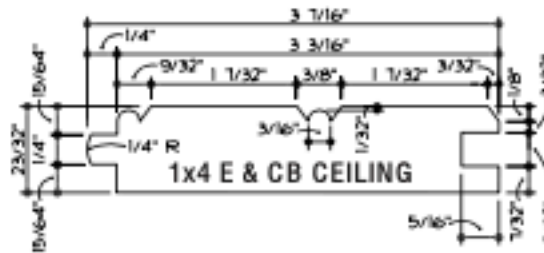
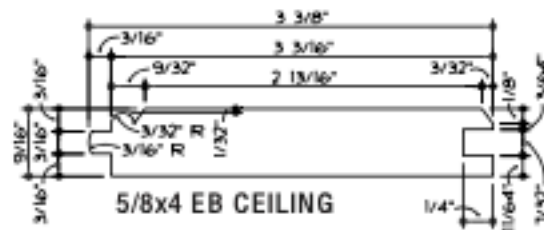

Partition

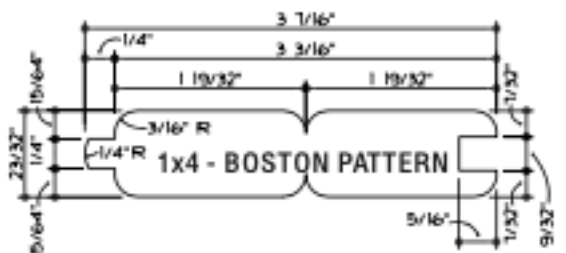
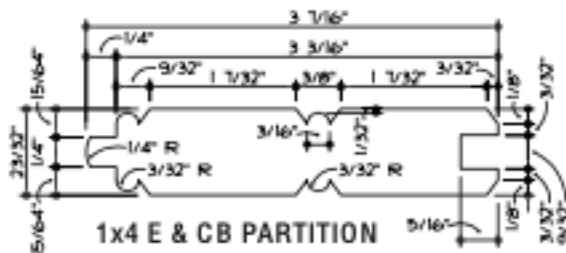
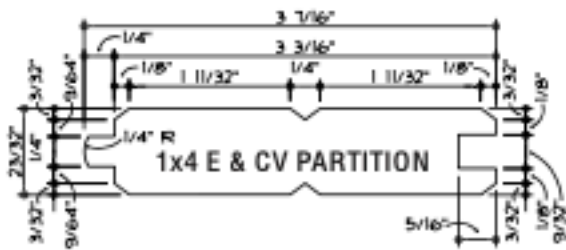
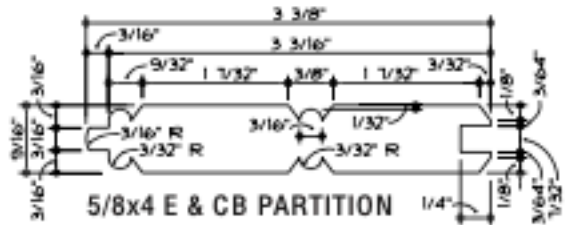
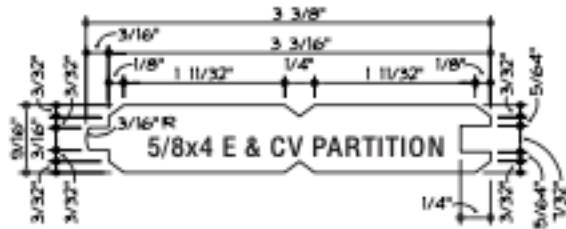
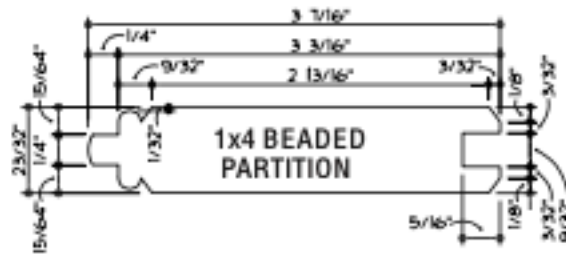

Shiplap

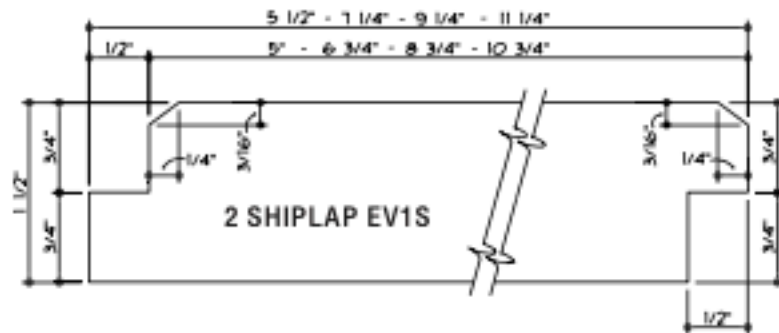
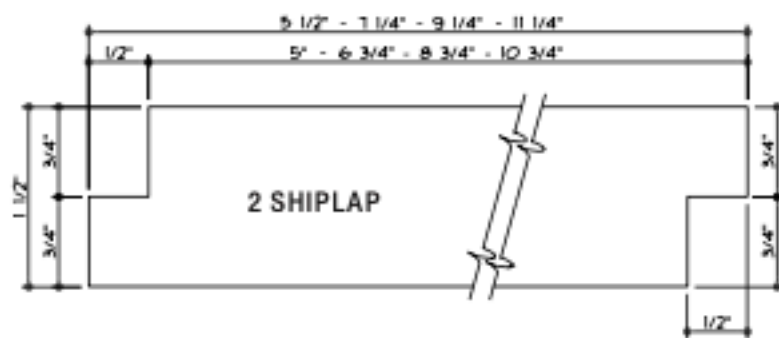
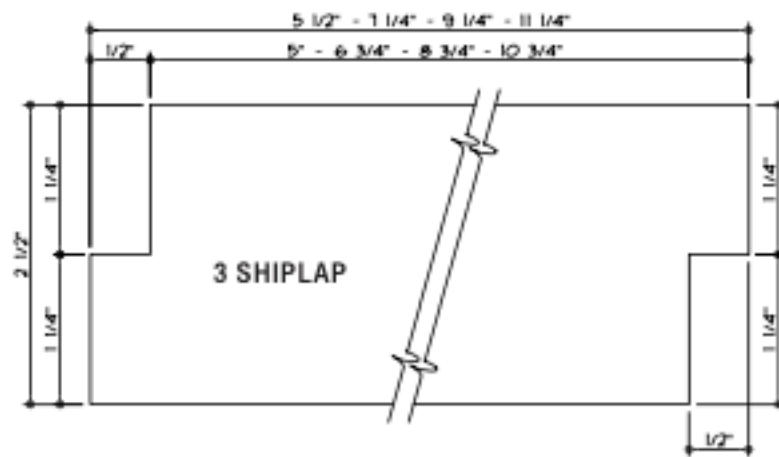
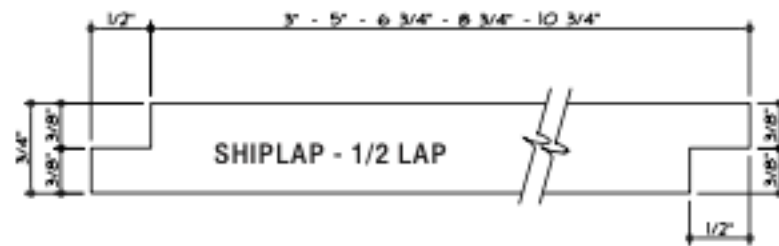
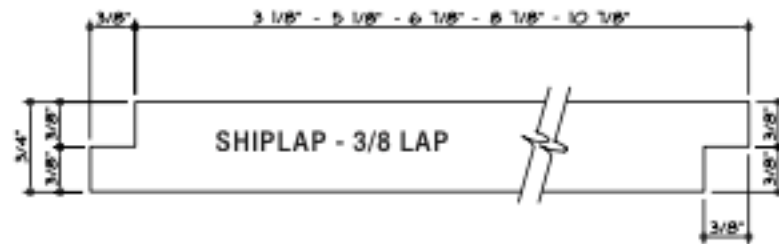

Tongued & Grooved, Decking

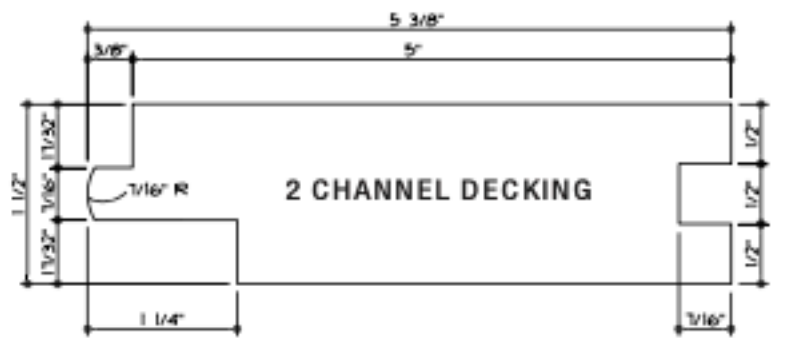
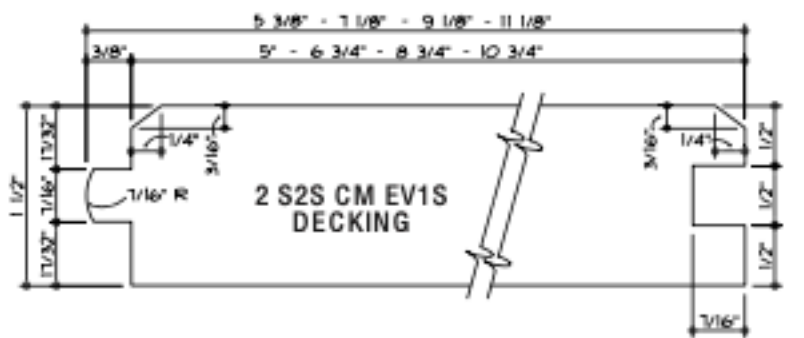
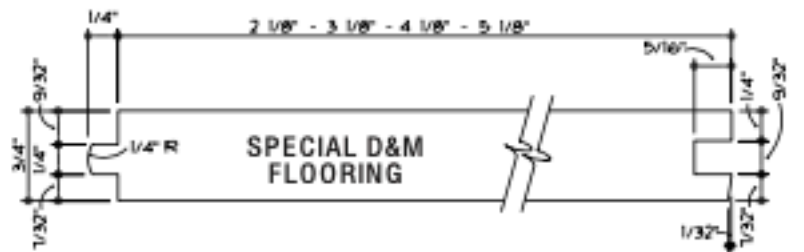
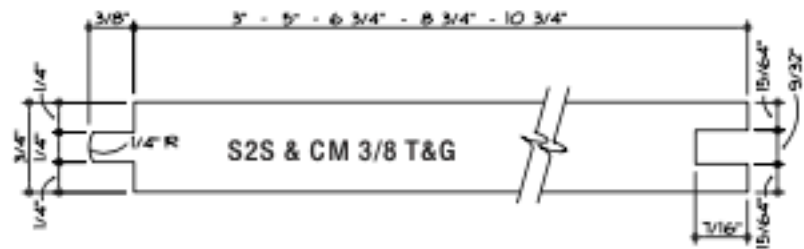
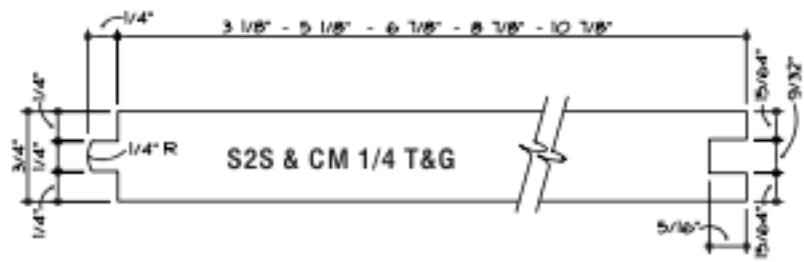

Decking

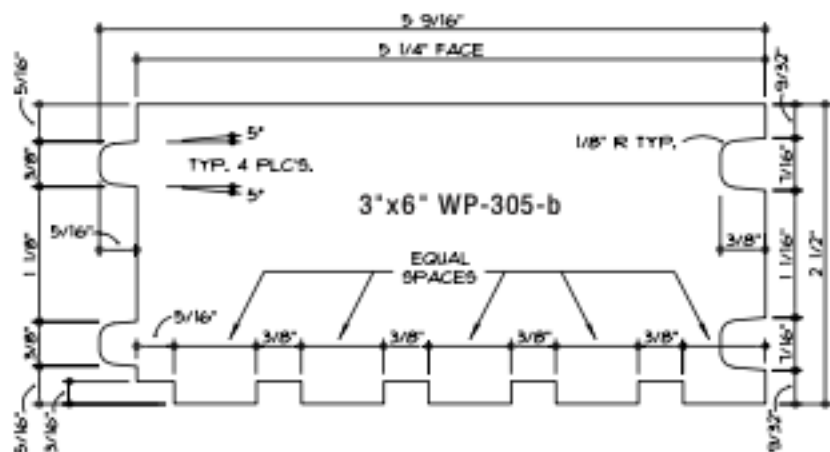
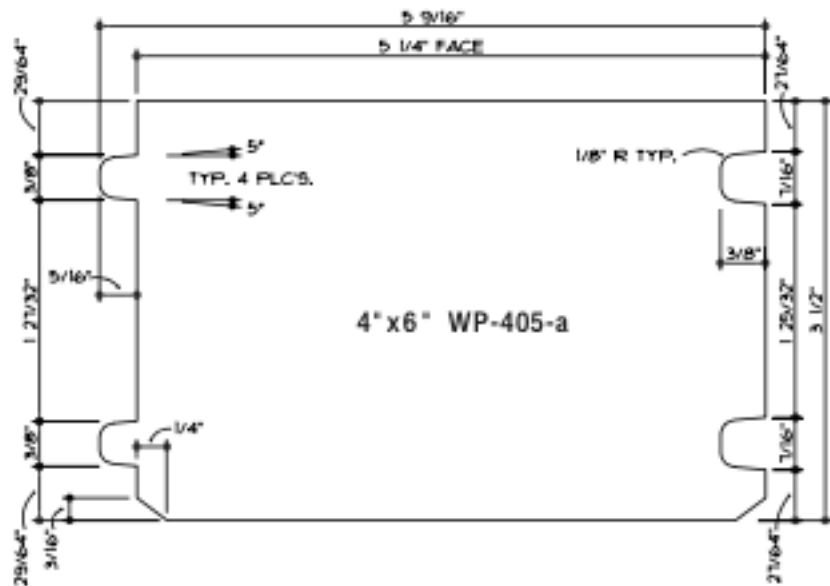
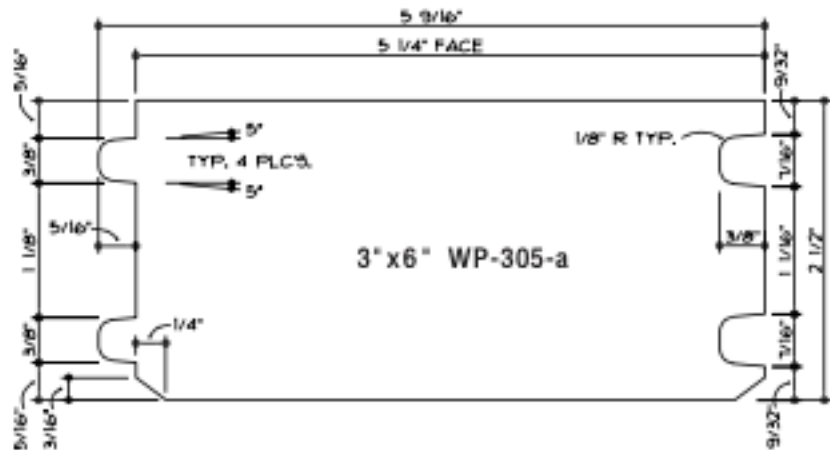

Decking

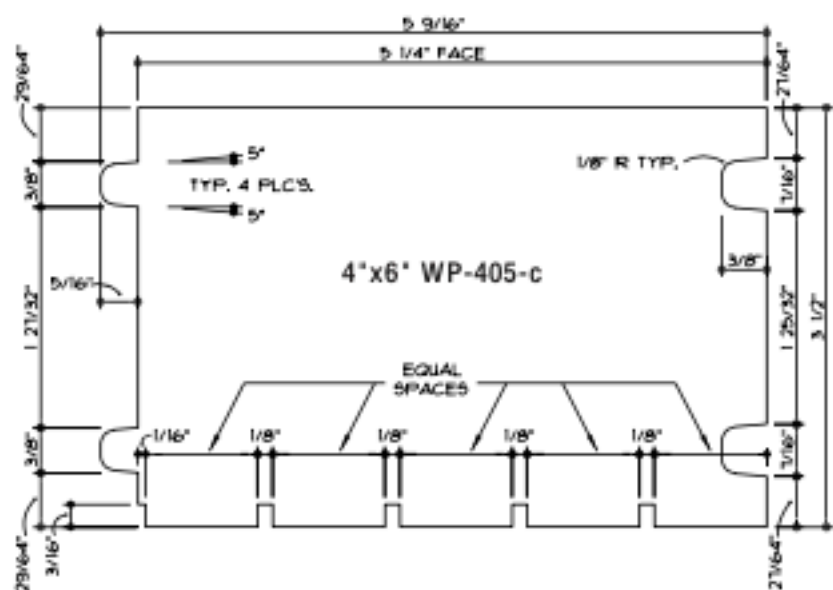
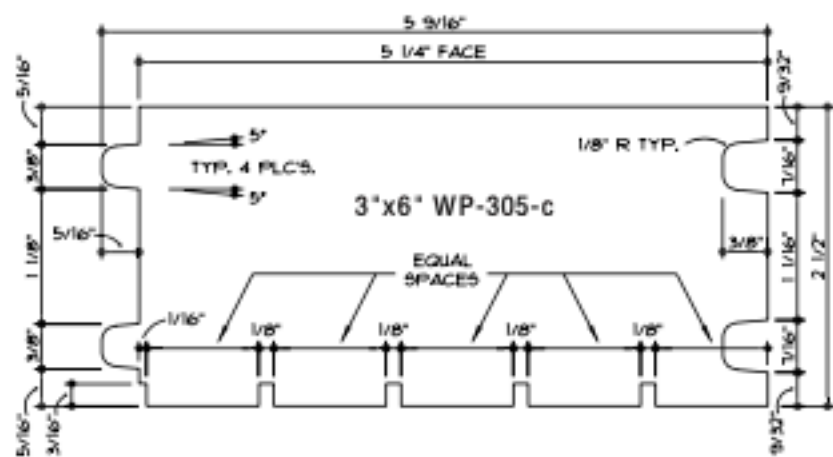
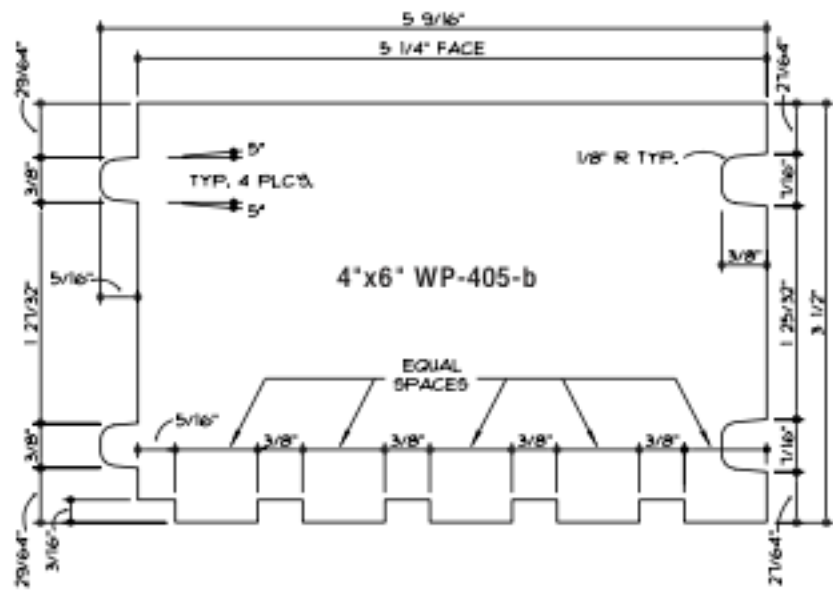

Decking

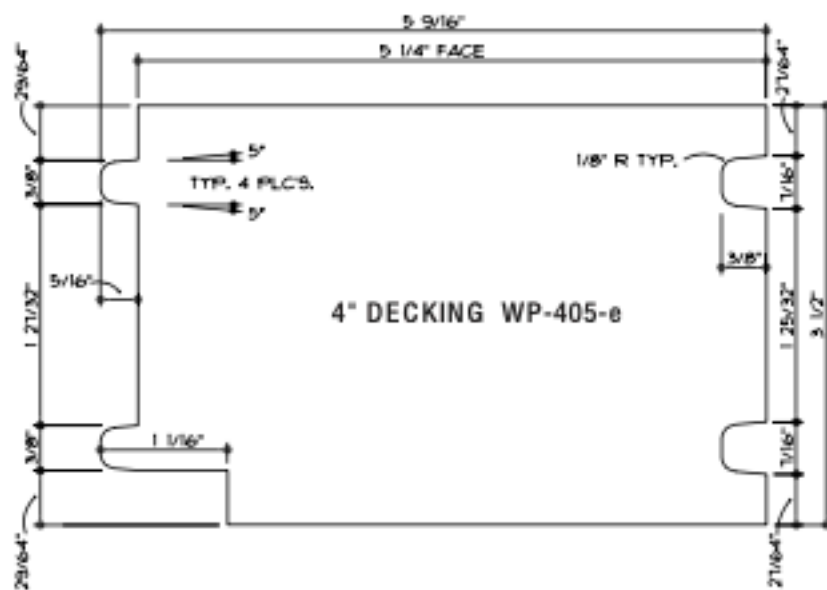
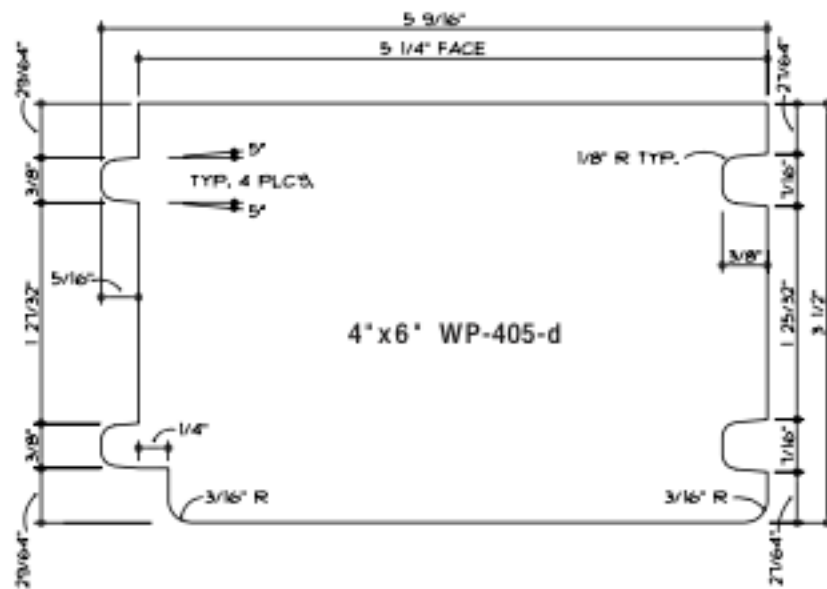
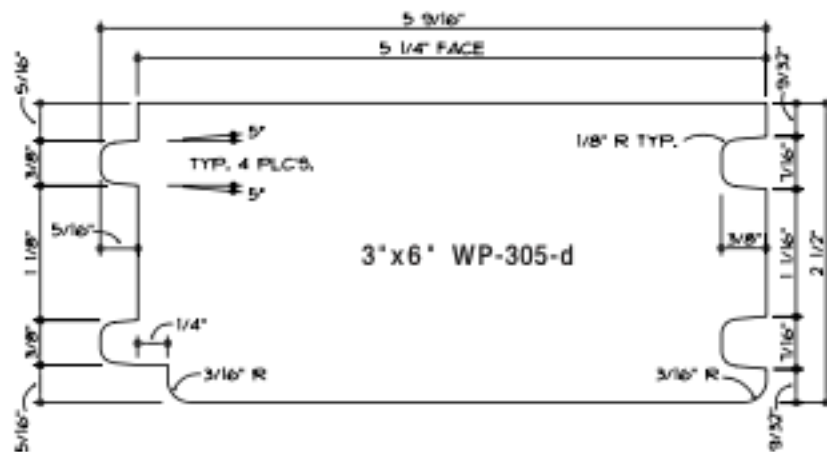

Decking and Flooring

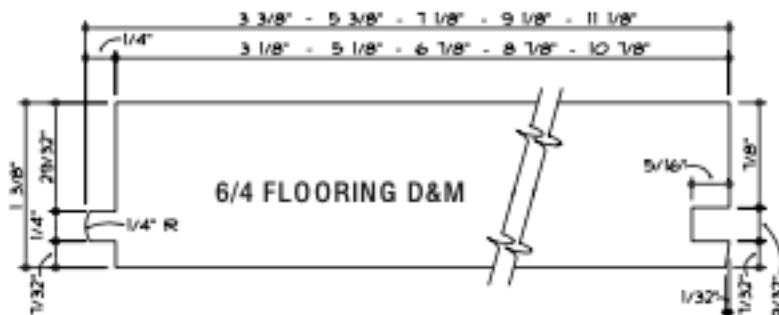
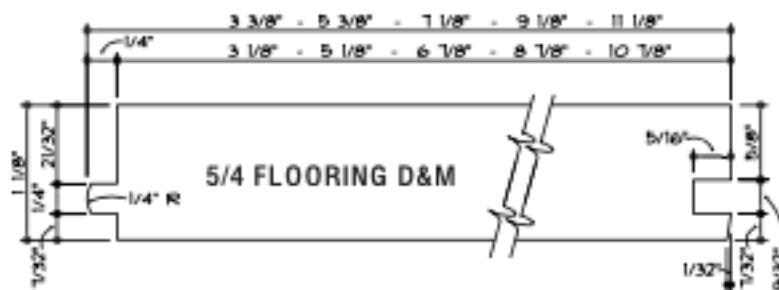
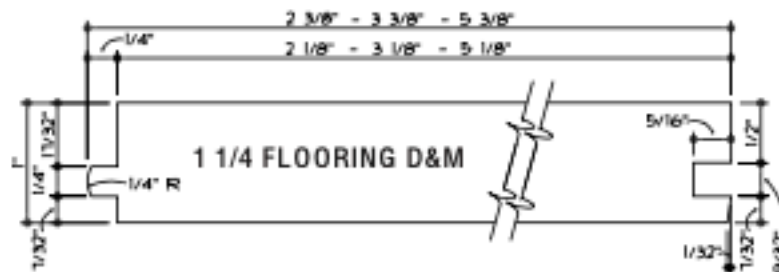
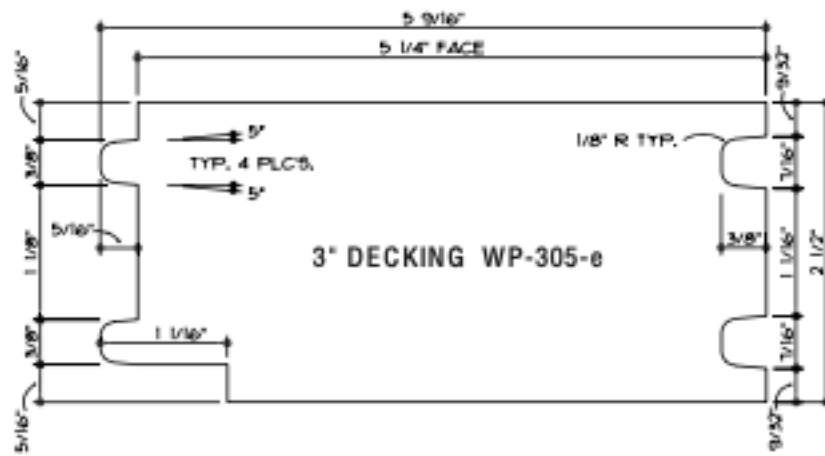

Flooring

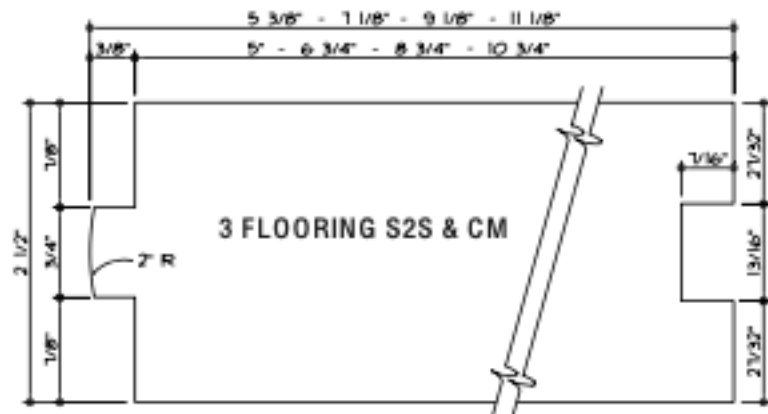
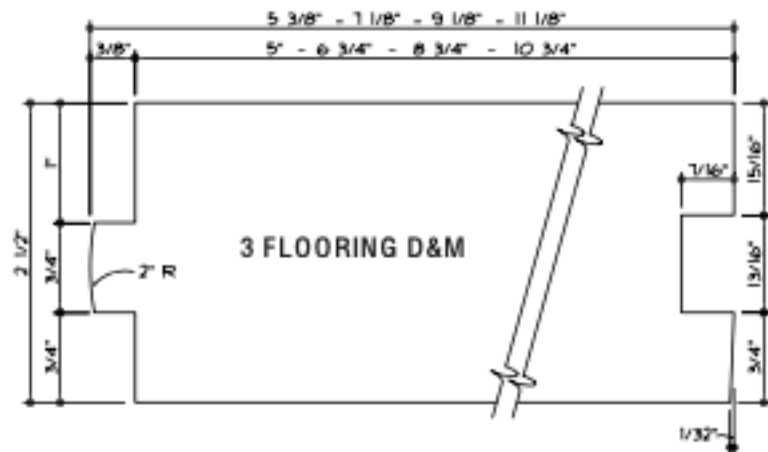
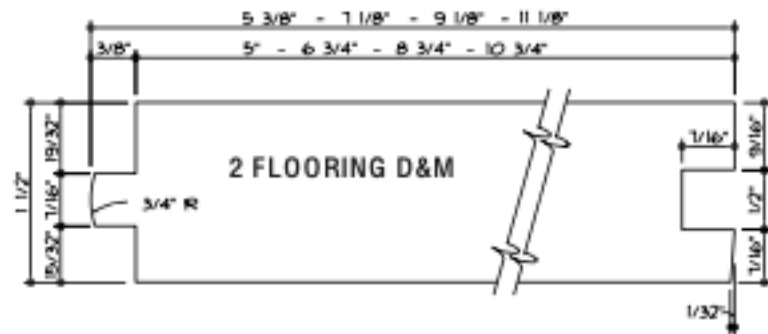

**Corn
Cribbing**

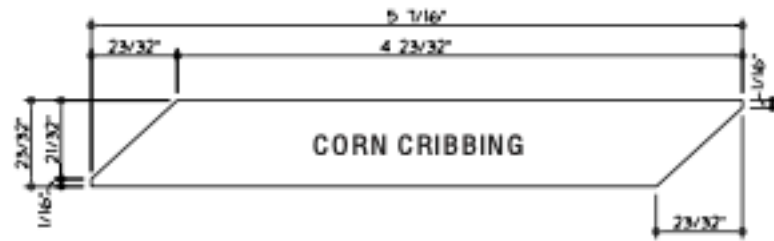

**Grooved
Roofing**

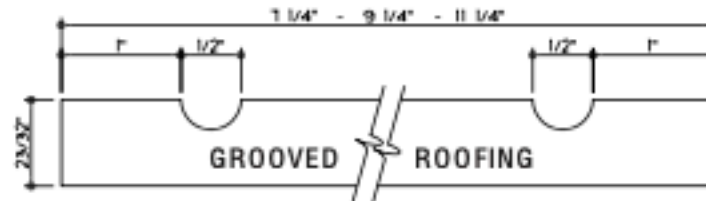

**Patent
Lath**

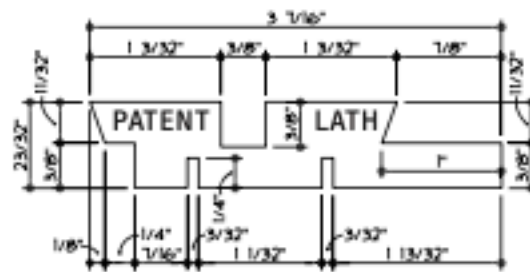

Stile

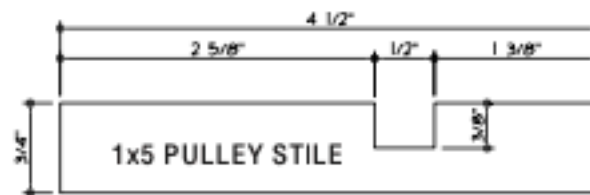

Sill

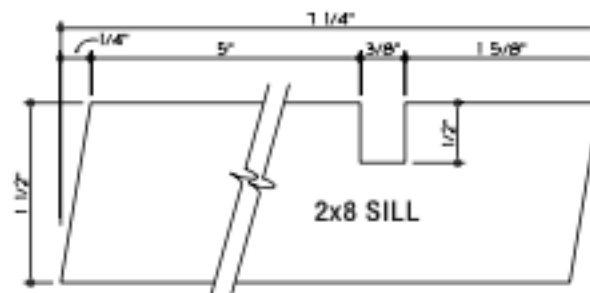

Jamb

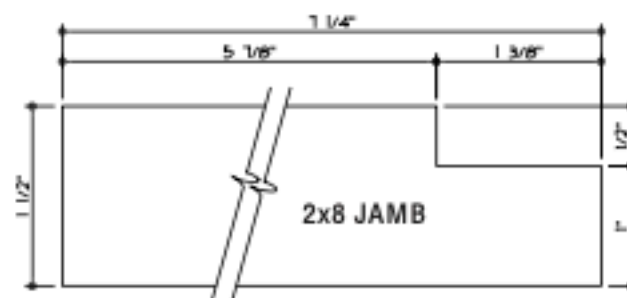

Ogee Batten

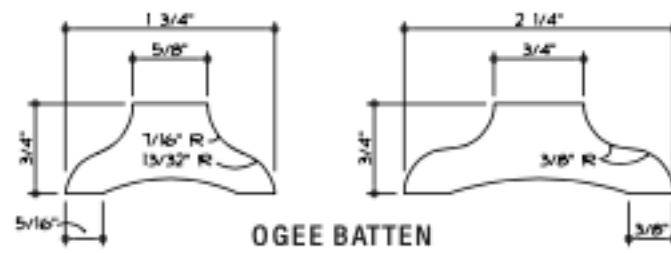

Casket Stock

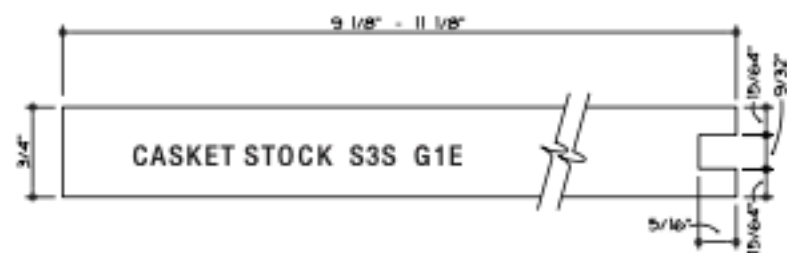
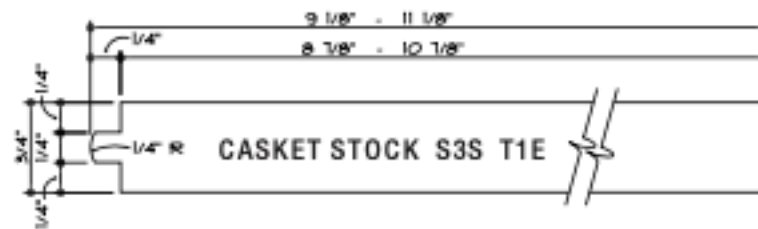

Beaded Shelving

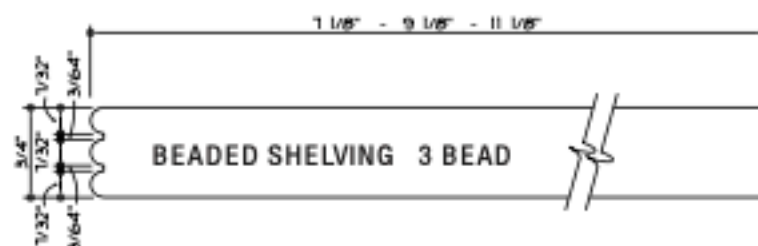
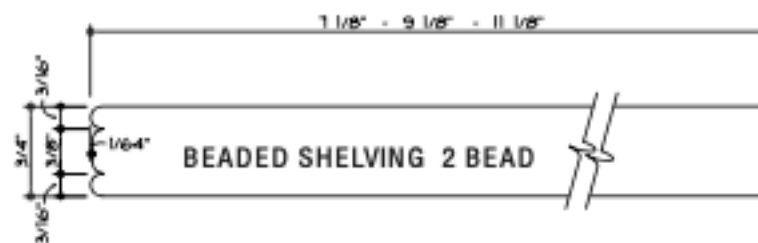

Unseasoned Tongued & Grooved

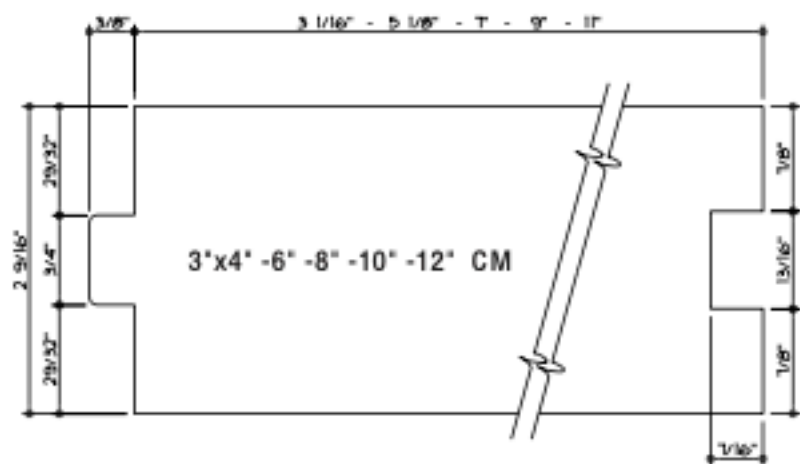
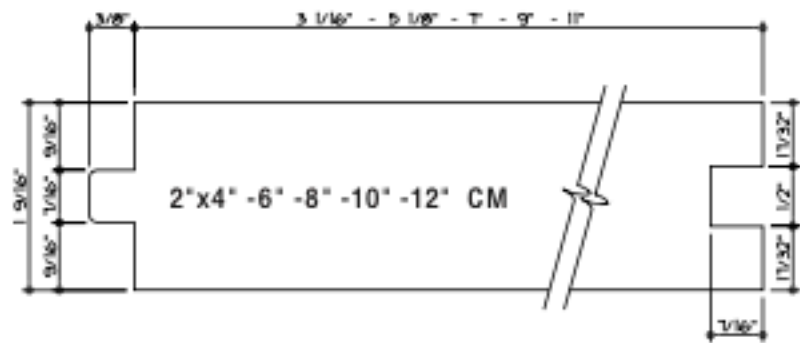
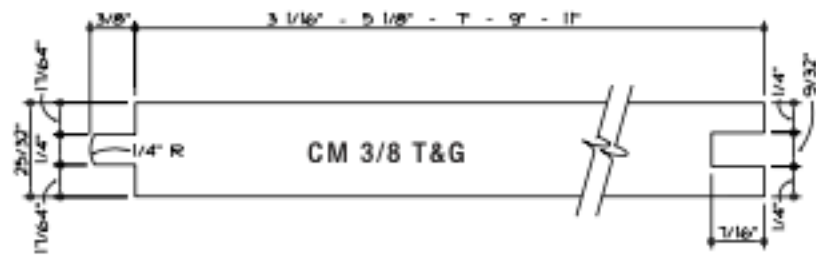
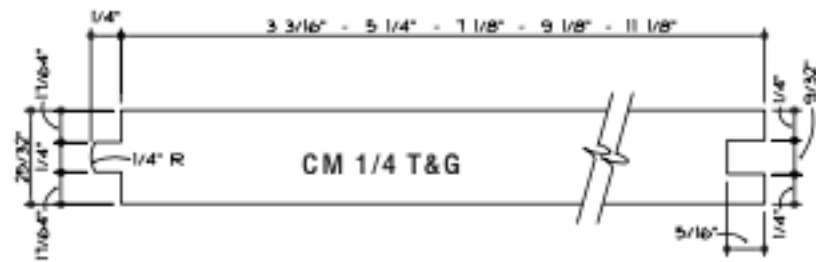

**Unseasoned
Tongued & Grooved**

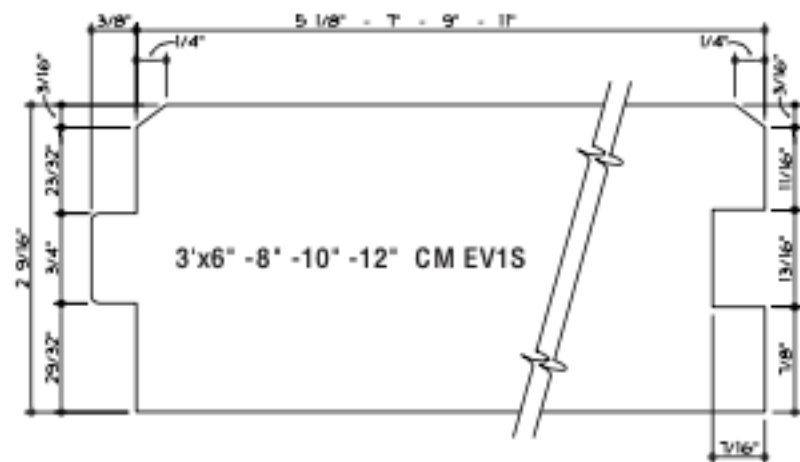
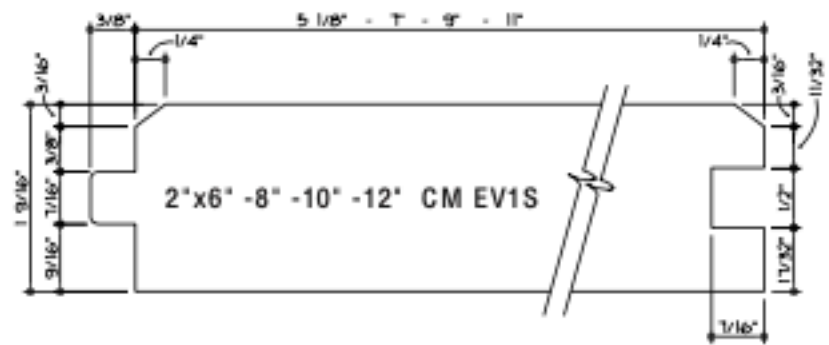

**Unseasoned
Shiplap**

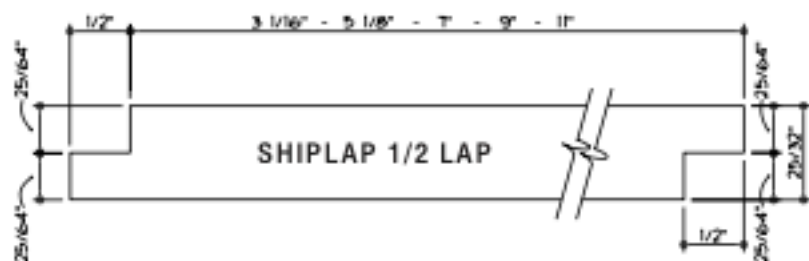
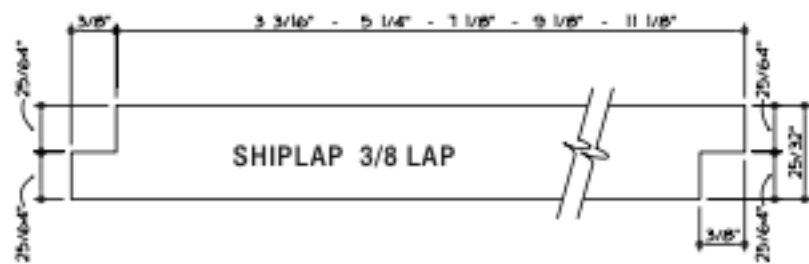

Tongued & Grooved, Decking

